

# КАТАЛОГ

## Лабораторная линейка приборов



ГОМОГЕНИЗАТОРЫ, ДИСПЕРГАТОРЫ, СМЕСИТЕЛИ И ИЗМЕЛЬЧИТЕЛИ

**Архангельск** (8182)63-90-72  
**Астана** (7172)727-132  
**Астрахань** (8512)99-46-04  
**Барнаул** (3852)73-04-60  
**Белгород** (4722)40-23-64  
**Брянск** (4832)59-03-52  
**Владивосток** (423)249-28-31  
**Волгоград** (844)278-03-48  
**Вологда** (8172)26-41-59  
**Воронеж** (473)204-51-73  
**Екатеринбург** (343)384-55-89  
**Иваново** (4932)77-34-06

**Ижевск** (3412)26-03-58  
**Иркутск** (395)279-98-46  
**Казань** (843)206-01-48  
**Калининград** (4012)72-03-81  
**Калуга** (4842)92-23-67  
**Кемерово** (3842)65-04-62  
**Киров** (8332)68-02-04  
**Краснодар** (861)203-40-90  
**Красноярск** (391)204-63-61  
**Курск** (4712)77-13-04  
**Липецк** (4742)52-20-81

**Киргизия** (996)312-96-26-47

**Магнитогорск** (3519)55-03-13  
**Москва** (495)268-04-70  
**Мурманск** (8152)59-64-93  
**Набережные Челны** (8552)20-53-41  
**Нижний Новгород** (831)429-08-12  
**Новокузнецк** (3843)20-46-81  
**Новосибирск** (383)227-86-73  
**Омск** (3812)21-46-40  
**Орел** (4862)44-53-42  
**Оренбург** (3532)37-68-04  
**Пенза** (8412)22-31-16

**Россия** (495)268-04-70

**Пермь** (342)205-81-47  
**Ростов-на-Дону** (863)308-18-15  
**Рязань** (4912)46-61-64  
**Самара** (846)206-03-16  
**Санкт-Петербург** (812)309-46-40  
**Саратов** (845)249-38-78  
**Севастополь** (8692)22-31-93  
**Симферополь** (3652)67-13-56  
**Смоленск** (4812)29-41-54  
**Сочи** (862)225-72-31  
**Ставрополь** (8652)20-65-13

**Казахстан** (772)734-952-31

**Сургут** (3462)77-98-35  
**Тверь** (4822)63-31-35  
**Томск** (3822)98-41-53  
**Тула** (4872)74-02-29  
**Тюмень** (3452)66-21-18  
**Ульяновск** (8422)24-23-59  
**Уфа** (347)229-48-12  
**Хабаровск** (4212)92-98-04  
**Челябинск** (351)202-03-61  
**Череповец** (8202)49-02-64  
**Ярославль** (4852)69-52-93

<https://kinematica.nt-rt.ru> || [kcb@nt-rt.ru](mailto:kcb@nt-rt.ru)

## THE RANGE OF PRODUCTS

---

### **POLYTRON®**

#### **SERIES PT**

#### **FOR BATCH EMULSIONS / SUSPENSIONS**

- Dispersing of smallest amounts of plant, animal or human tissues in liquid e.g. for RNA extraction
  - Sample preparation
  - Wet milling and dispersing of solids, fibers, stringy materials, tissues, cells into fluids and polymers
  - Extractions
  - Breaking up of tablets for QC and further more ...
- 

### **MEGATRON®**

#### **SERIES MT (-V/-VP/-FM)**

#### **FOR FINEST INLINE EMULSIONS / SUSPENSIONS / DISPERSIONS**

- Dispersing and mixing of coarse solids into liquid
  - Producing of finest emulsions and suspensions with finest droplet and particle sizes
  - Intensive Mixing
  - Gassing of fluids
  - Special versions for foam production (MT-FM)
  - Special versions for powder induction (MT-VP) and further more ...
- 

### **REACTRON®**

#### **SERIES RT**

#### **COMPLETE DISPERSING SYSTEMS**

- Producing cremes, lotions, emulsions
  - Pharmaceutical or cosmetical products
  - Wet milling and dispersing of solids, fibers, stringy materials, tissues, cells into fluids and polymers
  - Extracting encymes from bio masses and further more ...
- 

### **POLYMIX®**

#### **SERIES PX**

#### **FOR MIXING AND STIRRING FOR DRY MILLING**

- Basic stirring and mixing tasks in the lab (PX-MT & PX-HT) and further more ...
  
  - Dry milling / grinding of dried, non-fatty, hard and brittle (cereals, beans, bones, stone,..) or stringy and ductile (wood, straw, fibres) products (PX-MFC) and further more ...
- 

### **MICROTRON®**

#### **SERIES MB**

#### **FOR MIXING AND HOMOGENIZING**

- Mixing, dispersing, homogenizing, emulsifying and size reduction of cuttable materials and further more ...
-

# POLYTRON® BIOTRONA® BATCH LAB & PILOT PLANT HOMOGENIZERS

POLYTRON® batch homogenizer for lab and pilot plant cover working volumes from about 0.1 ml up to about 50 liters. Basic models up to electronically controlled drive systems with computer interfaces are available and handle reliable different dispersing tasks.

The batch homogenizers are classified into lab handheld, small, medium and large benchtop units and pilot plant versions.

All POLYTRON® homogenizers to convince with the following features:

- quick coupling for the dispersing aggregates
- powerful and safe drive systems
- high speed levels / extreme high tip speeds
- intelligent regulations and / or controllers
- digital displays or readable scales
- long working life

From over 40 different and exchangeable POLYTRON® dispersing aggregates the optimum for each specific homogenizing application can be chosen.

The efficiency of POLYTRON® dispersing aggregates is unrivalled until now. Thanks to optimized shear forces and bounce effects the processed medium will be treated at finest level in shortest time.

POLYTRON® dispersing aggregates with EC design (standard) can be disassembled with effortless ease, are easily cleaned and can be sterilised / autoclaved according to all current methods.



Model / Series	for volumes up to	speed max.	Power	Ø generator	standard Shaft length	Further Description, Options
<b>PT 1200 E</b>	0.05 - 250 ml	28'000 rpm	100 W	3 - 12 mm	50 - 123 mm	1,9,11,14
<b>PT 1300 D</b>	0.05 - 250 ml	30'000 rpm	100 W	3 - 12 mm	50 - 123 mm	1,7,8,9,11,14
<b>PT 2500 E</b>	0.05 - 2000 ml	30'000 rpm	500 W	3 - 25 mm	50 - 170 mm	2,8,9,11,13,14
<b>PT 10-35 GT</b>	0.1 - 10'000 ml	30'000 rpm	1200 W	5 - 36 mm	78 - 250 mm	3,8,10,11,13,14
<b>PT 3100 D</b>	0.1 - 10'000 ml	30'000 rpm	1200 W	5 - 36 mm	78 - 250 mm	3,7,8,10,11,13,14
<b>PT 6100 D</b>	up to 30 l	26'500 rpm	1700 W	36-60 mm	250 mm	4,7,8,10,11,13,14
<b>PT 45-80 GT</b>	up to 30 l	26'500 rpm	1700 W	36-60 mm	250 mm	3,8,10,11,13,14
<b>PT 7100</b>	up to 40 l	12'000 rpm	1.5 kW	36-60 mm	400 mm	5,7,8,10,11,13,14
<b>PT-D 36-60 EX</b>	up to 50 l	12'000 rpm	~ 3.0 kW	36-60 mm	400 mm	5,6,8,10,11,12,13,14

Technical specification is indicative

Further Descriptions / Options	
1	Handheld Homogenizer Lab
2	Benchtop Homogenizer Lab „small“
3	Benchtop Homogenizer Lab „medium“
4	Benchtop Homogenizer Lab „large“
5	Pilot Plant Batch Homogenizer
6	ATEX versions available (standard II2G-T3 - Zone 1)
7	PC connection and User Interface Software available
8	Digital display
9	Quick Coupling type E for Dispersing Aggregates
10	Quick Coupling type F for Dispersing Aggregates (also Dispersing Aggregates with coupling type B can be connected)
11	Dispersing aggregate in EC design; easily disassembled and cleaned or sterilized
12	Dispersing aggregates / shafts available as C (PT-C series) design for CIP
13	Dispersing aggregates available with mechanical seal systems for pressure and/or vacuum applications
14	Special shaft lengths possible

POLYTRON® Generator (PTG) PTG 5/2 Standard generator rotor/stator with one teeth row each	PTG 7/2 Standard generator rotor/stator with one teeth row each	PTG 12/2 Standard generator rotor/stator with one teeth row each	PTG 20/2 Standard generator rotor/stator with one teeth row each	PTG 20/2M Special <b>M-Generator</b> Rotor with knives rotor/stator with one teeth row each	PTG 20/2W Special <b>W-Generator</b> rotor/stator with one teeth row each	PTG 30/2Z Special <b>Z-Generator</b> rotor/stator with one teeth row each
Maximum Tip Speed 6 m/s	8 m/s	14 m/s	21 m/s	21 m/s	21 m/s	34 m/s
Working volume 0.1 - 5 ml	0.3 - 10 ml	3 - 250 ml	20 - 2000 ml	20 - 2000 ml	20 - 2000 ml	100 - 4000 ml
<b>Applications</b> - Dispersing smallest plant, human or animal pieces - Dissolving solids - Extractions	- Dispersing cells and tissues in a small amount of liquid - Dissolving solids - Extractions	- Dispersing plant, human or animal tissues, resins and pigments - Dissolving solids - Extractions - Producing suspensions and emulsions	- Dispersing plant, human or animal tissues, resins and pigments - Dissolving solids - Extractions - Producing suspensions and emulsions	- Dispersing and mixing particles up to 10 mm in size - Sample preparation for extraction and solution organic material - Intensive mixing - Rotor with knives facilitate the processing larger cell tissue samples or particles	- Dispersing fibrous, stringy and brittle samples (e.g. flesh)	- Breaking open and dispersing pills, capsules and hard large grains

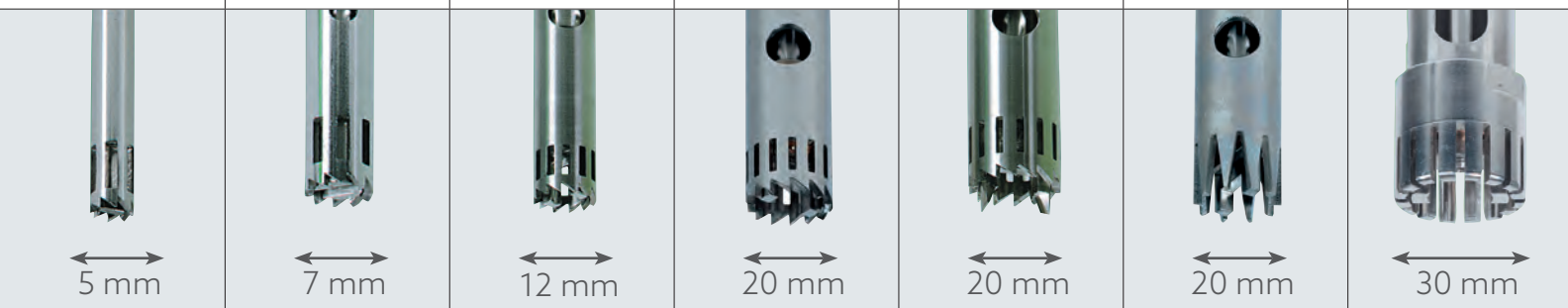

**POLYTRON® PT 10-35 GT**



**POLYTRON® PT 3100 D**



**POLYTRON® PT 45-80 GT**



**USER SOFTWARE**







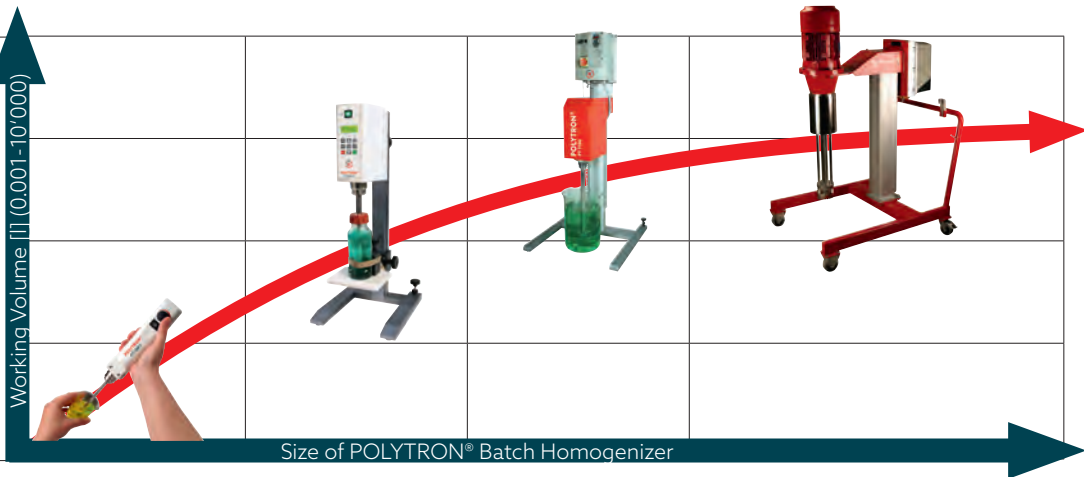

- Suitable for PC's using MS-Windows
- Possibility of data logging into MS-Excel-sheets for all parameters
- Programmable Speed-Time-Profiles for automatic operation
- Programmable temperature limits for use as stopping criteria to avoid product overheating
- Graphical parameter visualization in time-based diagram
- Written parameter visualization in text boxes
- Drive health and status is displayed
- Available for PT 3100 D, PT 6100 D and PT 1300 D

**SCALE-UP**

KINEMATICA offers a complete series of batch working homogenizers suitable for volumes from 0.05 ml up to 10'000 liters.

Test results obtained with lab units can be used as a reliable data source for a scale-up step to the larger POLYTRON® pilot plant and production machines.



PTG 30/4TiN Special generator titan-nitrated Rotor/stator with two teeth rows each	PTG 36/2 Standard generator Rotor/stator with one teeth row each	PTG 36/2W Special <b>W-Generator</b> Rotor/stator with one teeth row each	PTG 36/4 Standard generator Rotor/stator with two teeth rows each	PTG 36/4G Special <b>G-Generator</b> with mechanical seal Rotor/stator with three teeth rows each	BAG 36 <b>BIOTRONA</b> ® Generator blade rotor and stator with inclined slots	PTG 40/2 Standard generator Rotor/stator with one teeth row each
34 m/s	34 m/s	34 m/s	34 m/s	34 m/s	34 m/s	36 m/s
200 - 4000 ml	200 - 4000 ml	200 - 4000 ml	100 - 2500 ml	100 - 2500 ml	500 - 10'000 ml	200 - 5000 ml
- Fine emulsions and suspensions - Mixes and reduces highly intensive solids into fluids - Gasses solutions - Separate fibres and cellular material into very small particles - Extractions - Applications with abrasive components	- Dispersing and mixing of particles up to 15 mm in size - Sample preparation for extraction and solution of organic material - Intensive mixing	- Dispersing fibrous, stringy and brittle samples (e.g. flesh)	- Fine emulsions and suspensions - Mixes and reduces highly intensive solids into fluids - Gasses solutions - Separate fibres and cellular material into very small particles - Extractions	- Working under pressure / vacuum - Finest emulsions and suspensions - Mixes and reduces highly intensive solids into fluids - Gasses solutions - Separates fibres and cellular material into very small particles - Extractions - Prevents foam built-up	- High turbulent mixing with low shear forces - Fast dissolving and suspending of solids also at higher viscosity	- Dispersing and mixing of particles up to 20 mm in size - Sample preparation for extraction and solution of organic material - Intensive mixing
 30 mm	 36 mm	 36 mm	 36 mm	 36 mm	 36 mm	 40 mm



POLYTRON® PT 6100 D



POLYTRON® PT 7100



POLYTRON® PT-D 36-60 (EX)



The selection of the right dispersing aggregate and the right drive system depends on the application: treated medium, viscosity, processing time, volume, etc. KINEMATICA don't leave you alone with these difficult questions. Our applications team would like to discuss with you the right system components for successful working in accordance to a filled-in questionnaire or a test run in our laboratory. A short overview about available dispersing aggregates and systems shall give you a first information.

Aggregates Systems	Ø 3 mm	Ø 5 mm	Ø 7 mm	Ø 12 mm	Ø 20 mm	Ø 25 mm	Ø 30 mm	Ø 36 mm	Ø 40 mm	Ø 45 mm	Ø 50 mm	Ø 60 mm
PT 1200 E	+++	+++	+++	++								
PT 1300 D	+++	+++	+++	++								
PT 2500 E	++	++	+++	+++	+++	++						
PT 10-35 GT		+	++	+++	+++		+++	++				
PT 3100 D		+	++	+++	+++		+++	++				
PT 6100 D		+	+	+	++		+++	+++	+++	++	++	+
PT 45-80 GT		+	+	+	++		+++	+++	+++	++	++	+
PT 7100		+	+	+	+		++	+++	+++	+++	+++	++
PT-D 36-60 (EX)		+	+	+	+		+	++	+++	+++	+++	+++

+ limited adapted    ++ well adapted    +++ very well adapted

Which aggregates are available for my drive system?



Which designs are available for my dispersing aggregate?



POLYTRON® Generator PTG PTG 40/2M Special <b>M-Generator</b> Rotor with knives Rotor/stator with one teeth row each	PTG 40/2W Special <b>W-Generator</b> Rotor/stator with one teeth row each	PTG 45/2 Standard generator Rotor/stator with one teeth row each	PTG 45/2M special <b>M-Generator</b> Rotor with knives rotor/stator with one teeth row each	PTG 45/6 standard generator rotor/stator with three teeth rows each	BAG 45 <b>BIOTRONA®</b> Generator blade rotor and stator with inclined slots	PTG 50/2 Standard generator Rotor/stator with one teeth row each
Maximum Tip Speed 36 m/s	36 m/s	40 m/s	40 m/s	40 m/s	40 m/s	44 m/s
Working volume 200 - 4000 ml	200 - 5000 ml	200 - 6000 ml	200 - 6000 ml	200 - 4000 ml	1000 - 15 000 ml	300 - 10 000 ml
<b>Applications</b> - Dispersing and mixing of particles up to 20 mm in size - Sample preparation for extraction and solution of organic material - Intensive mixing - Rotor with knives facilitate the processing of larger cell tissue samples or particles	- Dispersing of fibrous, stringy and brittle samples (e.g. flesh)	- Dispersing and mixing of particles up to 22 mm in size - Sample preparation for extraction and solution of organic material - Intensive mixing	- Dispersing and mixing of particles up to 22 mm in size - Sample preparation for extraction and solution of organic material - Intensive mixing - Rotor with knives facilitate the processing of larger cell tissue samples or particles	- Making finest emulsions and suspensions - Mixes and reduces highly intensive solids into fluids - Gasses solutions - Separates fibres and cellular material into very small particles - Extractions	- High turbulent mixing with low shear forces - Fast dissolving and suspending of solids also at higher viscosity	- Dispersing and mixing of particles up to 25 mm in size - Sample preparation for extraction and solution of organic material - Intensive mixing

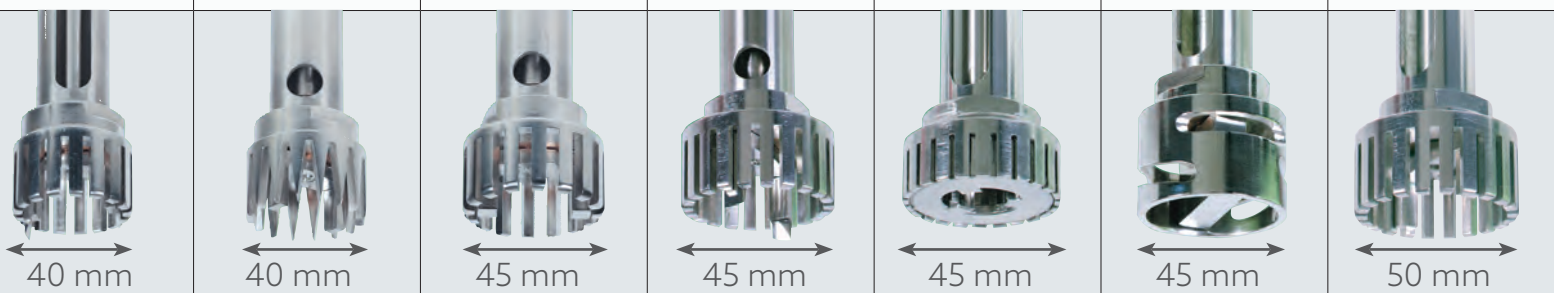

**DISPERSING AGGREGATES**

**SAFE AND FAST QUICK COUPLINGS**

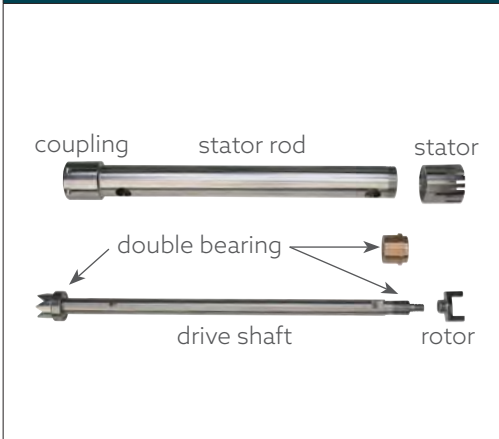

**THE RIGHT DISPERSING VESSEL**



Aggregates	Ø 3 mm	Ø 5 mm	Ø 7 mm	Ø 12 mm	Ø 20 mm	Ø 25 mm	Ø 30 mm	Ø 36 mm	Ø 40 mm	Ø 45 mm	Ø 50 mm	Ø 60 mm
Design „Stator tube“												
Slotted					+	+	+	+	+	+	+	+
EC (Standard)	+	+	+	+	+	+	+	+	+	+	+	+
G					+	+	+	+	+	+	+	+
T				+	+	+	+	+	+	+	+	+
Aggregates	Ø 3 mm	Ø 5 mm	Ø 7 mm	Ø 12 mm	Ø 20 mm	Ø 25 mm	Ø 30 mm	Ø 36 mm	Ø 40 mm	Ø 45 mm	Ø 50 mm	Ø 60 mm
..2 (R/S with 1TR each)	+	+	+	+	+	+	+	+	+	+	+	+
..4 (R/S with 2TR each)							+	+	+	+	+	+
..6 (R/S with 3TR each)										+	+	+
M Rotor				+	+	+	+	+	+	+	+	+
W Stator				+	+	+	+	+	+	+	+	+
Z Stator							+					
BIOTRONA®								+		+		

+ equipable, TR = teeth row(s), R/S = rotor/stator (= dispersing generator)

- **EC-Design** Easy-Clean, easy disassembled, easy cleaned or sterilized
- **G-Design** Pressure, vacuum, anti-foam, with mechanical seal
- **M-Generator** Rotor with knives for precutting
- **W-Generator** For fibrous and stringy material
- **Z-Generator** For hard and brittle material
- **BIOTRONA®** High turbulences, low shear forces

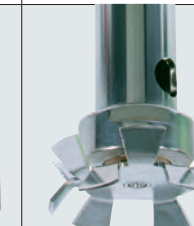
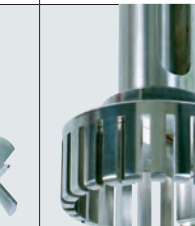
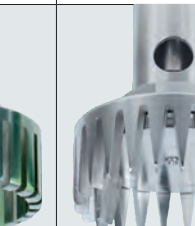
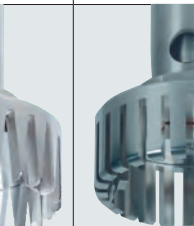
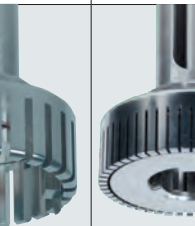
PTG 50/2M Special <b>M-Generator</b> Rotor with knives Rotor/stator with one teeth row each	PTG 50/6G Special <b>G-Generator</b> with mechanical seal Rotor/stator with three teeth rows each	PTG 58 DI Special dissolver disk	PTG 60/2 Standard generator Rotor/stator with one teeth row each	PTG 60/2W Special <b>W-Generator</b> Rotor/stator with one teeth row each	PTG 60/2M Special <b>M-Generator</b> Rotor with knives Rotor/stator with one teeth row each	PTG 60/6 Standard generator Rotor/stator with three teeth rows each
44 m/s	44 m/s	47 m/s	50 m/s	50 m/s	50 m/s	50 m/s
300 - 10 000 ml	300 - 4000 ml	1000 - 40 000 ml	200 - 4000 ml	1000 - 30 000 ml	1000 - 30 000 ml	1000 - 20 000 ml
- Dispersing and mixing of particles up to 25 mm in size - Sample preparation for extraction and solution of organic material - Intensive mixing - Rotor with knives facilitate the processing of larger cell tissue samples or particles	- Working under pressure / vacuum - Making finest emulsions and suspensions - Mixes and reduces highly intensive solids into fluids - Gasses solutions - Separates fibres and cellular material into very small particles - Extractions - Prevents foam built-up	- Fast mixing and homogenizing of solid material into fluid by means of a dissolving disk - Preparing highly viscous products	- Dispersing and mixing of particles up to 30 mm in size - Sample preparation for extraction and solution of organic material - Intensive mixing	- Dispersing of fibrous, stringy and brittle samples (e.g. flesh)	- Dispersing and mixing of particles up to 30 mm in size - Sample preparation for extraction and solution of organic material - Intensive mixing - rotor with knives facilitate the processing of larger cell tissue samples or particles	- Making finest emulsions and suspensions - Mixes and reduces highly intensive solids into fluids - Gasses solutions - Separates fibres and cellular material into very small particles - Extractions
 50 mm	 50 mm	 58 mm	 60 mm	 60 mm	 60 mm	 60 mm

With the type series MEGATRON® MT and MEGATRON® MT-V KINEMATICA has set standards once more for the inline homogenizing technology regarding efficiency, safe operation and long working life of the machinery for a broad application area within almost every industry field.

The MEGATRON® family can be divided into three branches with high, medium and low shear rates. With decades of experience KINEMATICA can be your reliable partner and advisor on choosing the right level of shear rate for your application and product.

Inline homogenizer for pilot plant and production:

- Throughputs from 50 l/h up to approx. 150'000 l/h
- high speed levels and tip speeds up to approx. 50 m/s
- adjustable drive systems with power levels between approx. 1.2 kW and 100 kW
- dispersing generators with rotor diameters between 15 mm and 300 mm; with fineness steps from coarse to medium to fine to super fine for reaching particle sizes within the lowest micrometer range respective the upper nano meter range depending on the properties of the treated products
- vertically or horizontally installed single- or multi-staged working chambers
- single or double acting mechanical sealing systems including supply systems
- Sterile versions, as well as CIP / SIP, 3A and ATEX versions can be supplied
- product wetted parts made from high-alloyed stainless steel and sealing materials conform with the product



Model / Series	Throughput max.	Tip speed max.	Rotor speed max.	Rotor-Ø	Disp. Generator Stages	Power
<b>MT 3100 S²</b>	11 l/min	42 m/s	30'000 rpm	15 - 26 mm	1	1.2 kW
<b>MT 5100 S²</b>	75 l/min	37 m/s	21'000 rpm	30 - 40 mm	1	1.5 kW
<b>MT-V 45 (EX)</b>	40 l/min	41 m/s	12'000 rpm	45 mm	1, 2 or 3	up to 4.0 kW

## FOAM PRODUCTION

Model / Series	Drive Power	Rotor-Ø	Teeth rows/ stages 2/6	Throughput l/h liquid
<b>MT-FM 30</b>	1.5 kW	30 mm	8/5	10
<b>MT-FM 50</b>	4.0 kW	50 mm	12/8	40

The market of foamed products in the field of chemistry, pharma and food has heavily increased over the last few years. This not least because through the foaming process various product features can be adapted easier to modern trends and the quality and life time has considerably increased. In collaboration with the ETH Zürich KINEMATICA has brought to the market a new generation of foam processors with the series of MEGATRON FM.

A striking feature of this series is the generation of smallest micro bubbles in the scale of 5 - 10 µm and its narrow distribution due to a brandnew rotor stator geometry. The extremely effective foam processor MEGATRON FM works constantly and is available in different versions for laboratory and pilot plant size for product and recipe development with some liters throughput and in various sizes/performances for the production up to several 1000 liters throughput considering different working and environmental conditions.

We are happy to provide you with professional advise and to offer you all desirable accessories e.g. metering pumps with premixing container and mixer, cooling aggregate, process control. Some typical applications in food are: foamed protein, foamed milk products, foamed ice cream, mousse-products, foamed confectionary, bread pastries and foamed filling products.



Technical specification is indicative

MEGATRON® Generator MTG Type MTG 20/2 FFV generator	Type MTG 30/2 M generator	Type MTG 30/4 F generator	Type MTG 30/4 FFV generator	Type MTG 30/2M generator
- Standard modell, available for system MT 3100 S - Rotor/stator with one teeth row each	- Standard modell, available for system MT 3100 S - Rotor/stator with one teeth row each	- Standard modell, available for system MT 3100 S - Rotor/stator with two teeth rows each	- Standard modell, available for system MT 3100 S - Rotor/stator with two teeth rows each	- Standard modell, available for systems MT 5100 S - Rotor/stator with one teeth row each
Maximum Tip Speed 24 m/s	38 m/s	41 m/s	42 m/s	32 m/s
Throughput Up to 5 l/min (depends on the medium)	Up to 11 l/min (depends on the medium)	Up to 7 l/min (depends on the medium)	Up to 6 l/min (depends on the medium)	Up to 55 l/min (depends on the medium)
Applications - Dispersing, mixing and dissolving of solids in liquids - Suspending, deagglomeration, extraction - Pre-crushing of organic materials in liquids - intensive mixing	- Dispersing, mixing and dissolving of solids in liquids - Suspending, deagglomeration, extraction - Crushing of organic materials in liquids - Intensive mixing - Producing of emulsions (coarse to medium droplet sizes)	- Producing of fine suspensions and emulsions - Intensive dissolving of solids - Gassing of liquids - Crushing of fibers, tissue and cell materials in liquids - Producing of microspheres - Acceleration of reactions and chemical precipitations	- Producing of super fine suspensions and emulsions (very small droplet sizes) - Gassing of liquids - Crushing of fibers and tissue materials in liquids - Producing of microspheres - Acceleration of reactions and chemical precipitations - In general for applications which requires high shear rates	- Dispersing and mixing of coarse solids into liquid - Size reduction of coarse solids in liquid - Extractions - Mixing of fluids - Crushing of lumps - Intensive mixing

KINEMATICA offers also a range of complete homogenizing and mixing plants for different applications in the chemical, pharmaceutical, cosmetical and food industry - known under the brand name REACTRON®.

REACTRON® systems are designed to customer specifications and consist normally of the following components: processing tank with POLYMIX® stirring system for macro mixing, POLYTRON® / MEGATRON® homogenizing system for down sizing and micro mixing, piping, process control and further specific equipment like vacuum pumps, heating / cooling thermostates in accordance with the customer, the product and the process.

REACTRON® systems are available for batch and semi-batch operation with volumes starting from 1 liter up to several 100 liters. They can be designed and manufactured according to customer and application specifications, incl. pressure / vacuum, CIP / SIP, clean room design and ATEX regulations.

Some application examples:

- Producing of cremes, lotions, emulsions
- Pharmaceutical or cosmetical products
- Dispersing of fine solids into a liquid or molten phase
- Suspending of additives and solid polymers in mineral oils
- Wet milling and dispersing of solids, fibers, stringy materials, tissues, cells into fluids and polymers
- Producing of diary products and diet food
- Polymerisations
- Extracting of encymes from bio masses
- and further more ...

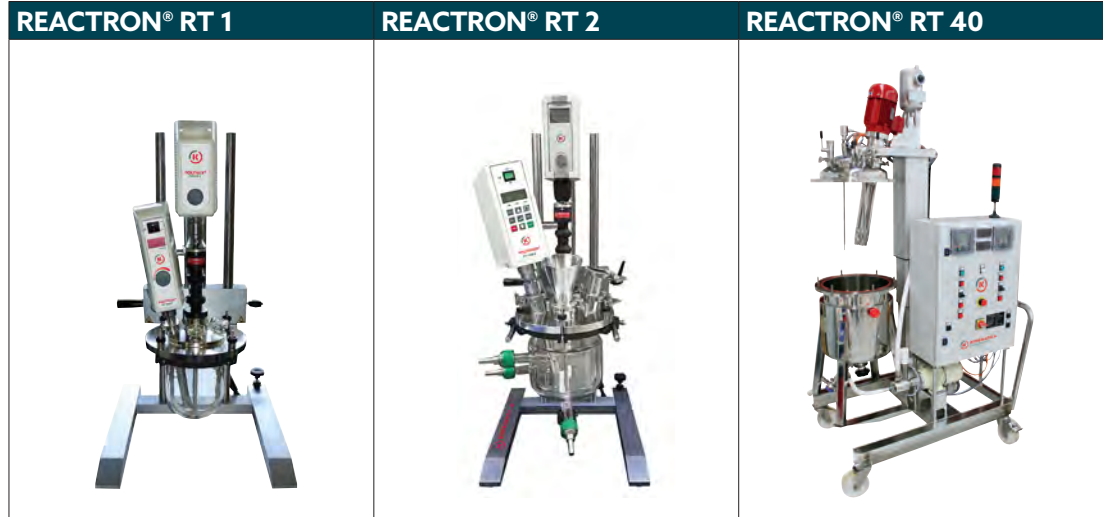

## POWDER INDUCTION

Model / Series	Drive Power	Rotor-Ø	Throughput l/h liquid	Suction capacity kg/h
MT-VP 45	up to 4.0 kW	45 mm	1000	70
MT-VP 65	up to 11.0 kW	65 mm	3000	200

After several years of development KINEMATICA succeeded in introducing to the market an extremely efficient powder dispersing machine with the series MEGATRON MT-VP.

Advantages of the new developed system are above all, that due to a strongly improved suction capacity unwanted lumps can be avoided during powder sucking and wetting; this averts for one thing a plugging of the powder supply line and improves at the same time the add-on homogeneous dispersing.

The generated high vacuum with a simultaneous high suction capacity is substantially independent of the liquid throughput and to a certain extent, also independent of the pressure at the outlet; this grants a dust-free incorporation into the liquid. It has been shown that the generatable suction capacity is sufficiently high that heavy powders, e.g. metal containing powders, can also be sucked in.

So enlarges the new MEGATRON MT-VP powder dispersing machine with its convective powder wetting system and a wide range of various dispersing generators the application in the field of chemistry, pharma and food.

The series includes at present six various sizes with a throughput related to water and depending on the used dispersing generator from approx. 1'000 l/h to 80'000 l/h.



Technical specification is indicative

Type MTG 30/4F generator - Standard modell, available for systems MT 5100 S - Rotor/stator with two teeth rows each	Type MTG 40/2G generator - Standard modell, available for systems MT 5100 S - Rotor/stator with one teeth row each	Type MTG 40/4M generator - Standard modell, available for systems MT 5100 S - Rotor/stator with two teeth rows each	Type MTG 40/6F generator - Standard modell, available for systems MT 5100 S - Rotor/stator with three teeth rows each	Type MTG 40/6FV generator - Special modell, available for systems MT 5100 S - Rotor/stator with three teeth rows each
34 m/s	35 m/s	37 m/s	37 m/s	35 m/s
Up to 47 l/min (depends on the medium)	Up to 75 l/min (depends on the medium)	Up to 53 l/min (depends on the medium)	Up to 45 l/min (depends on the medium)	Up to 47 l/min (depends on the medium)
- Producing of emulsions and suspensions with medium droplet and particle sizes - Wet milling of solids up to medium particle sizes - Extractions - Accelerating of reactions - Crushing of lumps - Intensive mixing	- Dispersing and mixing of coarse solids into liquid - Size reduction of coarse solids in liquid - Extractions - Mixing of fluids - Crushing of lumps - Intensive mixing	- Producing of emulsions and suspensions with medium droplet and particle sizes - Wet milling of solids up to medium particle sizes - Extractions - Accelerating of reactions - Crushing of lumps - Intensive mixing	- Producing of emulsions and suspensions with fine droplet and particle sizes - Wet milling of fine solids - Extractions - Accelerating of reactions - Gassing of fluids - Crushing of lumps - Cell disruption	- Producing of finest emulsions with finest droplet sizes - Gassing of fluids - Desagglomerations - Extractions - Cell disruption





POLYMIX® PX-MT (Medium-throughput) stirrer for simple and efficient homogenising applications, includes the drive with a light and well readable LCD-Display showing speed, actual number of rotations, torque and remaining time of processing.

The POLYMIX® PX-HT (High-throughput) stirrer for processing of high viscous products includes drive and unique KINEMATICA POLYMIX® KD-stirrer, drive holder, vessel holder and ST-P 20/600 plate-stand.

The lab mill POLYMIX® PX-MFC 90 D with exchangeable milling attachments and sieves with mesh sizes from 0.2 to 6 mm is suitable for all dry milling applications in the lab. Thanks to the powerful drive unit with LED display and high speed level the mill can process dried, non-fatty, hard and brittle products such as Cereals, corn, roasted coffee, beans, bones, stone, mortar, etc., as well as dried, non-fatty, stringy and ductile products such as Wood, leaves, straw, dried degreased meat, wool, cotton, paper, synthetic materials, etc.

The systems MICROTRON® MB 550 and MB 800 are specially designed for mixing, dispersing, homogenizing, emulsifying and size reduction of cuttable materials. The MB 550 is available with different attachments made from glass for volumes between 125 and 1000 ml. The MB 800 is available with mixing attachments made from stainless steel with volumes of 2 l and 4 l. The systems MB 550 and MB 800 are safety laboratory devices - grounded, double safety isolated, radio screened. A safety system prevents uncontrolled starting and therewith personal injuries.



Model / Series	For volumes	Speed max.	Power	Further Description, Options
<b>POLYMIX® Lab Stirrers</b>				
<b>PX-MT</b> Automatic Mortar/Pestle homogenizing system	up to 40 l	2'000 rpm	190 W	<ul style="list-style-type: none"> <li>- Electronic speed control from 50 up to 2000 rpm</li> <li>- Working volume - up to 40 liter (water)</li> <li>- Max. torque - 80 Ncm</li> <li>- LCD-Display</li> <li>- Suitable for liquids with viscosity up to 50'000 mPa·s</li> <li>- chuck can be fixed with only one hand - without tools</li> </ul>
<b>PX-HT</b> Stirrer for high viscous applications	up to 70 l	1'200 rpm	190 W	<ul style="list-style-type: none"> <li>- Electronic speed control from 20 up to 1200 rpm</li> <li>- Working volume - up to 70 liter (water)</li> <li>- Max. torque - 120 Ncm</li> <li>- Suitable for liquids with viscosity up to 100'000 mPa·s</li> <li>- Softstart for avoiding splashing and bubbles</li> <li>- Chuck can be fixed with only one hand - without tools</li> </ul>
<b>POLYMIX® Lab Grinding Mills</b>				
<b>PX-MFC 90 D</b>	300 ml (funnel)	6'000 rpm	1000 W	<ul style="list-style-type: none"> <li>- High power model (1.0 kW, 3-phase motor)</li> <li>- Low noise level, &lt;70 db(A) w/o load</li> <li>- Integrated speed control with LED for speed indication and status messages</li> <li>- Integrated overheating, overload and blocking protection</li> <li>- Safety switch for automatic-Off, energy saving through automatic Standby-Mode</li> <li>- Base frame made from anodised aluminium with integrated handle</li> </ul>

Other POLYMIX® Stirrers						
Propeller stirrer Standard stirrer available with 3 or 4 blades, Ø 45 - 100 mm	Turbine stirrer Standard stirrer, Ø 30 mm	Dissolver Standard stirrer, Ø 80 mm	Centrifugal stirrer Standard stirrer, Ø 60/15 mm	Flat stirrer Standard stirrer, Ø 70 mm	Anchor stirrer Standard stirrer, Ø 45 mm	Potter Special stirrers, Ø 8-25 mm available with / without cooling jacket
Maximum Speed 2000 rpm	2000 rpm	2000 rpm	2000 rpm	1000 rpm	1000 rpm	1000 rpm
Working volume up to 25'000 ml	up to 25'000 ml	up to 25'000 ml	up to 10'000 ml	up to 10'000 ml	up to 10'000 ml	2, 5, 15 & 50 ml
<b>Applications</b> - Stirrer with 3 blades. Favourable to flow. Top-down and bottom-up suction of the fluid. Low shear forces. - Standard stirrer, 4 blades. Top-down suction of the fluid. Local shear forces. Generates axial flow in the vessel	- Top-down suction of the fluid. Generates axial flow in the vessel. Low shear forces.	- Radial flow. Top-down and bottom-up suction of the fluid. High turbulences, high shear forces, particle crushing.	- Two blade stirrer. Open up at increasing speed. For stirring in round bottles with small bottle neck. Acts like a propeller stirrer.	- Tangential flow. Low turbulences. Good heat transfer. Sparing treatment of the product.	- Tangential flow, high shear rates in the border area. Few disposal at the vessel wall. Use at low speeds. Ideal for fluids with middle to high viscosity.	- Consisting of a mortar (borosilikat glass) and a pestle (PTFE). For homogenizing smallest amounts of tissue, pulping of cells and bacteria. No additional fluid necessary.



## POLYMIX® PX-MFC 90 D

## MICROTRON® MB 550

## MICROTRON® MB 800



Model / Series	For volumes	Speed max.	Power	Further Description, Options
<b>POLYMIX® Lab Grinding Mills</b>				
<b>PX-MFC 90 D (continued)</b>	300 ml (funnel)	6'000 rpm	1000 W	<ul style="list-style-type: none"> <li>- Milling chamber with attached funnel and rotary slide for product inlet; intercepting tubes and NS29 vessels can be attached to milling chamber outlet</li> <li>- Milling chamber can be equipped with hammer grinding or blade grinding attachment</li> <li>- Grinding attachments can be exchanged</li> <li>- Milling chamber can be equipped with sieves in different mesh sizes from 0.2 up to 6 mm</li> <li>- Milling chamber parts in contact with the product are made from stainless steel hardened</li> <li>- Packing unit consists of drive unit with milling chamber, grinding attachment, sieve 2.0 mm and tool set</li> </ul>
<b>MICROTRON® Mixers</b>				
<b>MB 550</b>	125 - 1'000 ml	14'000 rpm	550 W	<ul style="list-style-type: none"> <li>- 550 W high temperature safe universal motor with fan</li> <li>- Speed variable from 600-14000 rpm, soft start, speed scale</li> <li>- Thermal drive safety switch, electronical surveillance and stabilisation of the speed</li> <li>- Safety regulation for attachment surveillance, grounded with extra double safety isolation, radio screened</li> <li>- Mixing attachments made from glass available for volumes 125, 250, 500 and 1000 ml (safety huts to be ordered separately)</li> </ul>
<b>MB 800</b>	2 l - 4 l	14'000 rpm	800 W	<ul style="list-style-type: none"> <li>- As above but 800 W high temperature safe universal motor with fan</li> <li>- Mixing attachments made from stainless steel for volumes 2 and 4 liters</li> </ul>

Hammer grinding attachment	Blade grinding attachment	Sieves	Mixing attachments
Consisting of rotor with 3 impact hammers and stator with place for one exchangeable sieve	Consisting of rotor with 3 attached blades and stator with place for one exchangeable sieve	Available with mesh sizes from 0.2 mm up to 6 mm, for PX-MFC 90 D	Consisting of mixing head and vessel from glass (MB 550) or stainless steel (MB800), safety huts for MB 550 mixing attachments to be ordered separately
Maximum Speed 50 - 6'000 rpm	50 - 6'000 rpm	-	600 - 14'000 rpm
<b>Working volume</b> approx. 300 ml (funnel volume)	approx. 300 ml (funnel volume)	-	125, 250, 500, 1000 ml (MB550) 2000, 4000 ml (MB800)
<p><b>Applications</b></p> <p>- The impact grinding mill attachment is designed for processing dried, non-fatty, hard and brittle products such as:</p> <p>- Cereals, corn, malt, pectin, raw &amp; roasted coffee, beans, oats, nutshells, bones, fins (fish), gravel, stone, amber, mortar, etc.</p>	<p>- The blade grinding mill attachment is designed for processing dried, non-fatty, stringy and ductile products such as:</p> <p>- Wood, bark, roots, leaves, straw, cork, dried fruits, dried degreased meat, adenoids, fish, feathers, leather, dermis, wool, cotton, leashes, paper, coal, turf, dried resins, synthetic materials, fibre glass, plastic pellets, different textiles, felt, etc.</p>	-	<ul style="list-style-type: none"> <li>- Blending</li> <li>- Mixing</li> <li>- Dispersing</li> <li>- Homogenizing</li> <li>- Emulsifying</li> <li>- Milling of cuttable materials</li> </ul>

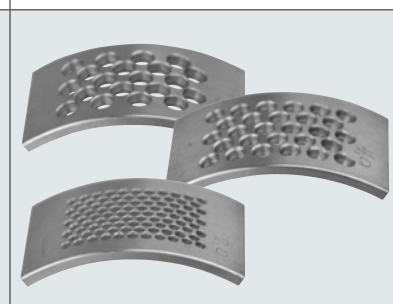
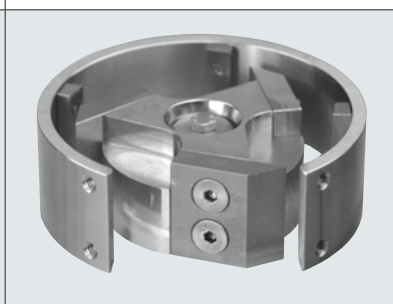
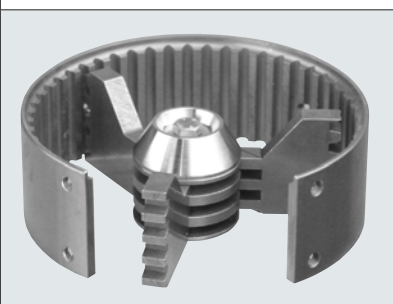



**Архангельск** (8182)63-90-72  
**Астана** (7172)727-132  
**Астрахань** (8512)99-46-04  
**Барнаул** (3852)73-04-60  
**Белгород** (4722)40-23-64  
**Брянск** (4832)59-03-52  
**Владивосток** (423)249-28-31  
**Волгоград** (844)278-03-48  
**Вологда** (8172)26-41-59  
**Воронеж** (473)204-51-73  
**Екатеринбург** (343)384-55-89  
**Иваново** (4932)77-34-06

**Ижевск** (3412)26-03-58  
**Иркутск** (395)279-98-46  
**Казань** (843)206-01-48  
**Калининград** (4012)72-03-81  
**Калуга** (4842)92-23-67  
**Кемерово** (3842)65-04-62  
**Киров** (8332)68-02-04  
**Краснодар** (861)203-40-90  
**Красноярск** (391)204-63-61  
**Курск** (4712)77-13-04  
**Липецк** (4742)52-20-81

**Киргизия** (996)312-96-26-47

**Магнитогорск** (3519)55-03-13  
**Москва** (495)268-04-70  
**Мурманск** (8152)59-64-93  
**Набережные Челны** (8552)20-53-41  
**Нижний Новгород** (831)429-08-12  
**Новокузнецк** (3843)20-46-81  
**Новосибирск** (383)227-86-73  
**Омск** (3812)21-46-40  
**Орел** (4862)44-53-42  
**Оренбург** (3532)37-68-04  
**Пенза** (8412)22-31-16

**Россия** (495)268-04-70

**Пермь** (342)205-81-47  
**Ростов-на-Дону** (863)308-18-15  
**Рязань** (4912)46-61-64  
**Самара** (846)206-03-16  
**Санкт-Петербург** (812)309-46-40  
**Саратов** (845)249-38-78  
**Севастополь** (8692)22-31-93  
**Симферополь** (3652)67-13-56  
**Смоленск** (4812)29-41-54  
**Сочи** (862)225-72-31  
**Ставрополь** (8652)20-65-13

**Казахстан** (772)734-952-31

**Сургут** (3462)77-98-35  
**Тверь** (4822)63-31-35  
**Томск** (3822)98-41-53  
**Тула** (4872)74-02-29  
**Тюмень** (3452)66-21-18  
**Ульяновск** (8422)24-23-59  
**Уфа** (347)229-48-12  
**Хабаровск** (4212)92-98-04  
**Челябинск** (351)202-03-61  
**Череповец** (8202)49-02-64  
**Ярославль** (4852)69-52-93